

DISCIPLINAS

BÁSQUETBOL, VOLEIBOL, FÚTBOL AMERICANO, WATERPOLO, BALÓN MANO,
PING PONG, BADMINTON, NATACIÓN, CICLISMO, ATLETISMO Y ÚTILES



 **RUNIC**®

A close-up photograph of a person's hand holding a basketball. The basketball is orange with black lines and features the brand name 'RUNIC' in large, bold, black letters. Below the brand name is the model number 'RK7R400'. At the bottom of the ball, it says 'OFFICIAL SIZE' and 'AIR GEL' in white letters with black outlines. The person holding the ball is wearing a black shirt with a red stripe on the sleeve. The background is a plain, dark grey color.

RUNIC
RK7R400

OFFICIAL SIZE
AIR GEL
with deep channels



RK3R300

HOT #3
CAUCHO
VULCANIZADO
8 PANELES



RK5R500

CAUCHO
VULCANIZADO
8 PANELES



RK5U100

1000
PU VULCANIZADO
8 PANELES



RK5KU36

PU CUERO HIGROSCÓPICO
VULCANIZADO
8 PANELES



RK6U101

1000
PU VULCANIZADO
8 PANELES



RK7R250

DUNKO
CAUCHO
VULCANIZADO
12 PANELES



#7

RK7R400

CAUCHO
VULCANIZADO
8 PANELES



#7

RK7UY70

100% TPU



#7

RK7U200

PULSE
PU VULCANIZADO
12 PANELES



#7

RK7UY90

100% TPU



#7

RK7UY06

100% PU



#7

RK7U100

1000
PU VULCANIZADO
8 PANELES



#7

RK7U900

PU
VULCANIZADO
12 PANELES



TABLERO

MEDIDA TABLERO: 112 X 73.5 CM
REF: SBA006



TABLERO

MEDIDA TABLERO: 110 x 75 CM
REF: SBA007



TABLERO

DIÁMETRO ARO: 45 CM EN ACERO DE 16 MM
MEDIDA TABLERO: 120 X 80 CM
MATERIAL: PC Y MARCO DE ACERO
INCLUYE NET DE NYLON.
RESISTENTE A LA INTEMPERIE
REF: SBA008



INCLUYE UNA MINI
BOLA DE 5" Y UN
INFLADOR

MINI HOOP

DIÁMETRO ARO: 9"
MEDIDA TABLERO: 18" X 12"

ARO DE BALONCESTO MINIATURA PARA INTERIORES, DE FÁCIL MONTAJE.
CON SOPORTE ACOLCHADO DE ESPUMA PARA NO DAÑAR LAS PUERTAS DE LA CASA
REF: RS9PMH1



TABLERO CON POSTE

ALTURA: 1.65 A 2.1 M

DIÁMETRO ARO: 38 CM EN ACERO DE 16 MM

MEDIDA TABLERO: 33" X 23"

BASE: SE PUEDE LLENAR CON 35 GALONES DE AGUA O ARENA PARA MAYOR ESTABILIDAD. CON RUEDAS PARA FÁCIL TRANSPORTE Y NET TRICOLOR.

REF: RS9MBS82

TABLERO CON POSTE

MEDIDA TABLERO: 120CM X 80 CM

DIÁMETRO ARO: 45 CM. PARA BALONCESTO ESTÁNDAR

MEDIDA TABLERO: 120 X 80 CM.

BASE: 110 X 75 X 20 CM. MATERIAL POLIETILENO (PE)

ALTURA AJUSTABLE: DE 230 A 305 CM

POSTE: TUBO DE METAL DE TRES PIEZAS PARA MAYOR SEGURIDAD, ASEGÚRESE DE QUE LA BASE ESTÉ SIEMPRE LLENA DE AGUA O ARENA 120 KG NO SE RECOMIENDAN LAS VOLCADAS Y LOS JUEGOS PELIGROSOS.

RESISTENTE A LA INTEMPERIE

REF: SBA025S

**SIN POSTE**

TABLERO

ALTURA : 2.30 A 3.05 M AJUSTE TRASERO

DIÁMETRO ARO: 45 CM EN ACERO DE 18 MM

MEDIDA TABLERO: 180 X 105 CM HASTA 150 M

MATERIAL: MARCO DE ALUMINIO Y VIDRIO
TEMPERADO DE 12 MM

POSTE: 1 PIEZA EN ACERO 152 MM. ALTURA 1.5M
RESISTENTE A LA INTEMPERIE

REF: SBA029TG - SIN POSTE



TABLERO CON POSTE

ALTURA: 3.05 M POSTE PLEGABLE

DIÁMETRO ARO: 45 CM EN ACERO DE 19 MM

MEDIDA TABLERO: 180 X 105 CM X 12 MM

POSTE: 3 TUBOS DE ACERO DE 76 MM

BASE: 195 X 100 X 0.8 M

INCLUYE RUEDAS EN LA BASE

NET DE NYLON. RESISTENTE A LA INTEMPERIE

REF: SG-1



CON POSTE

SIN POSTE



TABLERO

ALTURA : 2.30 A 3.05 M TORNILLO JACK ADJUSTABLE

DIÁMETRO ARO: 45 CM EN ACERO DE 16 MM

MEDIDA TABLERO: 136 X 80CM

MATERIAL: VIDRIO TEMPLADO CON PE

POSTE: 3 PIEZAS DE ACERO DE 100 X 100 MM

BASE: 135 X 82 X 20 CM MOLDE SOPLADO EN PE.

CARGA 160 LTS DE AGUA

NET DE NYLON. RESISTENTE A LA INTEMPERIE

REF: SBA027 (CON POSTE)

REF: SBA027TG (SIN POSTE)

TABLERO CON POSTE

ALTURA : 2.30 A 3.05 M LEVANTAMIENTO DE POTENCIA

DIÁMETRO ARO: 45 CM EN ACERO DE 16 MM

MEDIDA TABLERO: 110 X 75 CM

MATERIAL: ACRÍLICO ENMARCADO EN PE

POSTE: 3 TUBOS DE ACERO DE 76 MM

BASE: 118 X 78 X 20 CM MOLDE SOPLADO EN PE.

CARGA 125 LTS DE AGUA

NET DE NYLON. RESISTENTE A LA INTEMPERIE

REF: SBA020



ARO

INCLUYE RED
REF: S-R2S



ARO CON RESORTE

INCLUYE: TORNILLOS PARA ANCLAJE Y NET
REF: S-R4



NET

2MM
REF: RBN10 - RWB - TRICOLOR
RBN10 - WT - BLANCA



RED SUPERIOR

REF: RKN7C102
ESTA RED CUMPLE CON EL ESTÁNDAR DE 12 BUCLES,
PATRÓN DE REJILLA DE 7 FILAS Y 20" DE LONGITUD.
IDEAL PARA BALONES DE BALONCESTO ESTÁNDAR.



TABLERO DE COACH PARA BASKETBOL

REF: 8369

TABLERO MAGNÉTICO 40 X 24 CM
INCLUYE PLUMAS BORRADOR Y
14 IMANES QUE REPRESENTAN A LOS
JUGADORES, EL ÁRBITRO Y EL BALÓN.

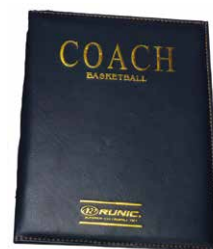

TABLERO DE COACH PARA BASKETBOL

REF: RCBY14B



RUMBLE
RV5U400®

**OFFICIAL
SIZE AND WEIGHT**



RVBV950



RVBV980



RVBV900

PVC
MEDIDA Y PESO OFICIAL



RVBV600

PVC COSIDO
PLAYA SOFT TOUCH
MEDIDA Y PESO OFICIAL



RV5V700

PVC TERMOLAMINADO
SOFT TOUCH
MEDIDA Y PESO OFICIAL



RV5UY10

100% PU



RV5U800

PU
MEDIDA Y PESO OFICIAL



RV5UY25

100% PU



RV5U200

TEAM SPORT SERIES
PU TERMOLAMINADO
MEDIDA Y PESO OFICIAL



RV5U360

PU LAMINADO A MANO
OLÍMPICO
MEDIDA Y PESO OFICIAL



RV5U400

PU SUPER SOFT TOUCH
PROFESIONAL
VULCANIZADO
FIVB
MEDIDA Y PESO OFICIAL



RV5U990

100% PVC
LAMINADO
SUPER SOFT TOUCH



RV-220SS

JAPAN PU
PROFESIONAL
LAMINADO
FIVB SUPER SOFT TOUCH



5487-6

SUPER SOFT TOUCH



RODILLERA ACOLCHADA

REF: RKP650 WT
RKP651 RD
RKP652 RY
RKP653 BK

RODILLERA BÁSICA

REF: RKP654 WT
RKP655 RD
RKP656 RY
RKP657 BK RKP657 - JR BK



RODILLERA ACOLCHADA ELITE

REF: RKP3W111 BK



CODERA ACOLCHADA ELITE

ALMOHADILLA DE PUNTO DE ESPUMA FLEXIBLE QUE SE DESLIZA FÁCILMENTE EN LOS CODOS PARA PROTEGER DE QUEMADURAS DE SUELO Y MORETONES DURANTE EL JUEGO.

PERFECTAS PARA SU USO EN SUPERFICIES DURAS DONDE SE HACE CONTACTO REPETIDO DEL CODO AL SUELO.

AYUDA DE APOYO PARA LA PREVENCIÓN DE LESIONES, PERFECTA PARA TODAS LAS EDADES Y NIVELES, PRINCIPIANTE A AVANZADO.

INCLUYE DOS (2) CODERAS LAVABLES A MÁQUINA

REF: REP3W001

COLOR: NEGRO

JR

REF: REP3W171

COLOR: NEGRO

ADULTO

NET VOLEIBOL



REF: RVN7C611
957X97 CM
HILO PE 2MM
MALLA 10X10CM
BANDA SUPERIOR DE 5CM EN PVC
LAMINADO, CON CABLE DE ACERO
RECUBIERTO DE 4 MM DE DIÁMETRO



REF: RVN7C806
970X105 CM
HILO PE ROSCADO 2MM
MALLA 10X10 CM
BANDA SUPERIOR DE 4CM EN
PVC CON CABLE DE ACERO
RECUBIERTO 3MM



REF: RVN7C614
952X100 CM
HILO PE 3MM,
MALLA 9.5X9.5 CM
BANDA SUPERIOR DE TELA 5CM
BANDA LATERAL E INFERIOR 4CM
PVC NEGRO
CABLE DE ACERO REVESTIDO
DE 3 MM



VOLEIBOL

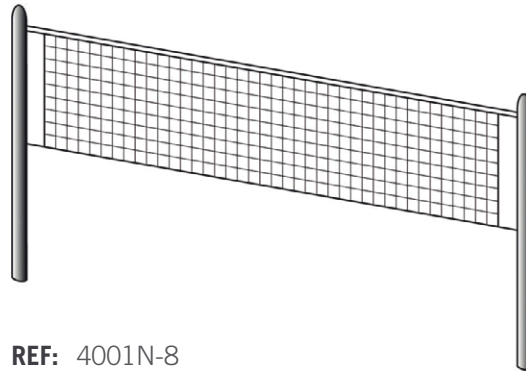

REF: 4001N-8
992X105 CM
HILO PE 2MM,
MALLA 9.5X9.5 CM
BANDA SUPERIOR, LATERALES
E INFERIOR 4CM PVC NEGRO
CABLE DE ACERO REVESTIDO DE 3 MM

REF: T4001N
968X97 CM
HILO 2MM,
MALLA 9.5X9.5 CM
BANDA SUPERIOR, LATERALES E INFERIOR
4CM PVC NEGRO
CABLE DE ACERO REVESTIDO DE 3 MM

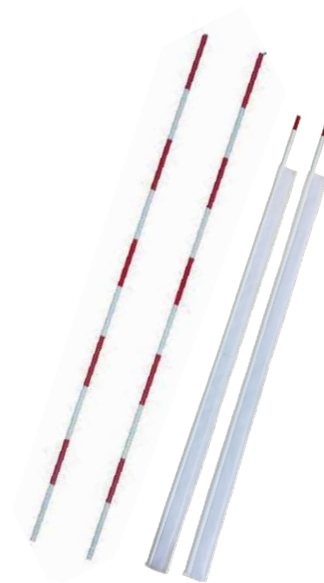

ANTENA VOLEIBOL

180 x 1 cm
REF: JPPG1 **PAR**
REF: 8113 **UNIDAD**



GORRA DEPORTIVA PERSONALIZABLE

100% POLYESTER
REF: GOLF



GORRA DEPORTIVA PERSONALIZABLE

100% LANA
REF: AC100



GORRA CLASSIC

UV UPF 50+
MESH Y MALLA
REF: CLASSIC

TALLA SM ML



GORRA PRO MESH

UV UPF 50+
100% COOL MESH
REF: PROMESH

TALLA SM ML

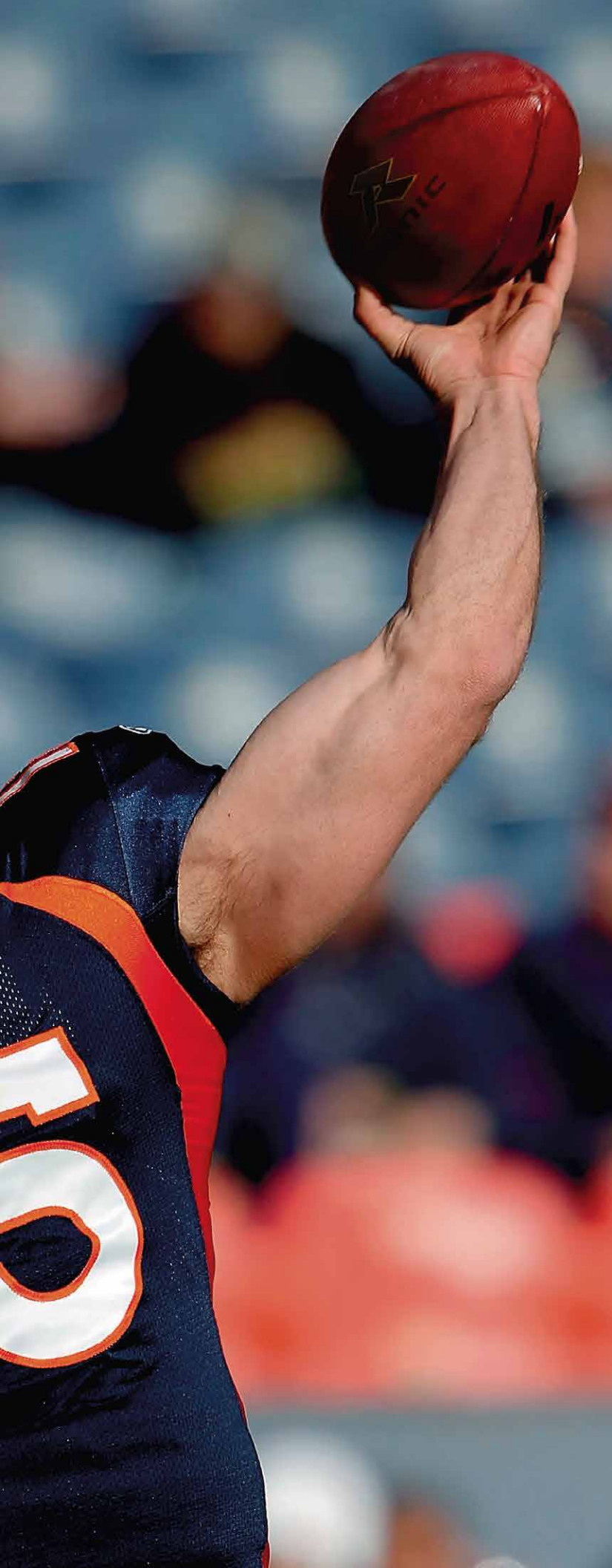

RAFKR52JR #6

CAUCHO
TAMAÑO OFICIAL JR



RAFW120PW #6

PU



RAFW360 #9



RAFW240JR #6

PU



KICKBALL



RKB10

100% CAUCHO

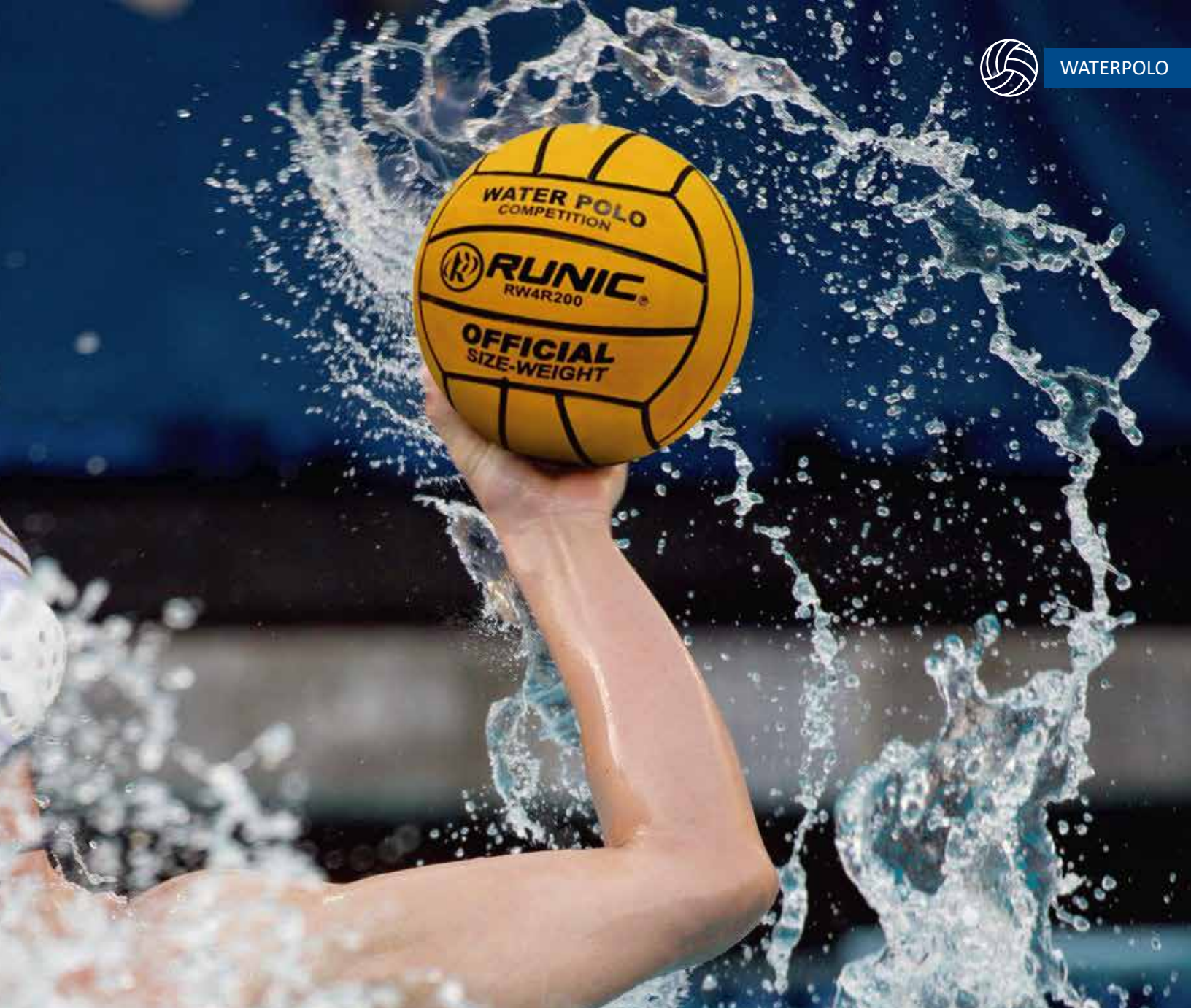

RW4R200 #4

WATER POLO
CAUCHO
VULCANIZADO
COMPETENCIA
MEDIDA Y PESO OFICIAL



SET RAQUETAS

INCLUYE: 4 RAQUETAS, 3 BOLAS,
POSTES Y NET
REF: RTT923



RAQUETA

REF: RTT336



SET RAQUETAS

INCLUYE: 2 RAQUETAS, 3 BOLAS,
POSTES Y NET
REF: RTT014



FORRO DE RAQUETAS DLX

REF: RTT798 -BK/RD
RTT798 - GY/BL



SET RAQUETAS

INCLUYE: 2 RAQUETAS, 2 BOLAS
REF: RTT207



SET DE RED Y POSTES PING PONG

REF: RTT981



RED Y POSTE SUPERIOR

REF: RTT002



RED

REF: RTT538



BOLA PING PONG

PELOTAS PARA COMPETENCIA 40MM.

ALTA CALIDAD

IDEAL PARA TORNEOS

TAMAÑO Y PESO OFICIAL

MATERIAL: 100% ABS

COLOR: BLANCO Y NARANJA

6 UNID.

REF: RTT7G00-WT

RTT7G00-OR



PROTECTOR DE MESA PING PONG

INDOOR
REF: RTTC01



 **USO INDOOR**



SOBRE DE 18MM MDF



MARCO DE 15X30MM



TREN DE 30X30MM



RED Y POSTES INCLUIDOS



FÁCIL Y SEGURO AL MOMENTO DE ABRIR Y CERRAR

4 RUEDAS DE PLÁSTICO DE Ø200, (2 CON FRENO Y 2 SIN FRENO).



COMPARTIMENTO PARA ALMACENAR RAQUETAS Y BOLAS

MESA DE PING PONG OUTDOOR

DIMENSIONES: 274 X 152.5 X 76 CM
PESO (MESA): 55 KG
INCLUYE RED Y SOPORTES
REF: R019SB



 **USO OUTDOOR**



SOBRE DE 4MM ACP



MARCO DE 15X30MM



TREN DE 30X30MM



RED Y POSTES INCLUIDOS



FÁCIL Y SEGURO AL MOMENTO DE ABRIR Y CERRAR

4 RUEDAS DE PLÁSTICO DE Ø200, (2 CON FRENO Y 2 SIN FRENO).



COMPARTIMENTO PARA ALMACENAR RAQUETAS Y BOLAS



MESA DE PING PONG BÁSICA CON RUEDAS

DIMENSIONES: 274 X 152.5 X 76 CM

PESO (MESA): 70 KG

8 RUEDAS DE PLÁSTICO DE Ø50 MM, 4 CON FRENO.

INCLUYE: RED Y SOPORTES

REF: R610B



 **USO INDOOR**



SOBRE DE 15 MM MDF



MARCO DE 15X23MM



TREN DE 30X30MM



RED Y POSTES INCLUIDOS



FÁCIL Y SEGURO AL MOMENTO DE ABRIR Y CERRAR

MESA DE PING PONG

DIMENSIONES: 274 X 152.5 X 76 CM

SUPERFICIE EN FIBRA VULCANIZADA DE ALTO REBOTE Y EXCELENTE TERMINACIÓN

PESO (MESA): 70 KG

FUNCIÓN FRONTÓN

MUY ROBUSTA Y TERMINACIÓN IMPECABLE

REF: R622B



 **USO INDOOR**



SOBRE DE 15MM MDF



MARCO DE 15X30MM



TREN DE 30X30MM



RED Y POSTES INCLUIDOS



MESA DE PING PONG CON RUEDAS

DIMENSIONES: 274 X 152.5 X 76 CM

PESO (MESA): 70 K

REF: R018B



 **USO INDOOR**



FÁCIL Y SEGURO AL MOMENTO DE ABRIR Y CERRAR

4 RUEDAS DE PLÁSTICO DE Ø200, (2 CON FRENO Y 2 SIN FRENO).

COMPARTIMENTO PARA ALMACENAR RAQUETAS Y BOLAS

MESA DE PING PONG DLX

DIMENSIONES: 274 X 152.5 X 76 CM

PESO (MESA): 102 KG

REF: R802B



 **USO INDOOR**

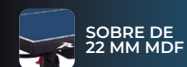

FÁCIL Y SEGURO AL MOMENTO DE ABRIR Y CERRAR



4 RUEDAS DE PLÁSTICO DE Ø200 CON FRENO.

COMPARTIMENTO PARA ALMACENAR RAQUETAS Y BOLAS



PLUMA DE ENTRENAMIENTO

12 UNIDADES
REF: 9



RED PARA BADMINTON

REF: BN-37010
COLOR: :Blanco / Rojo
CABLE DE 76 X 6,1 M



REF: K-2058 COLOR: AMARILLO NEÓN



REF: K-2058 COLOR: NARANJA NEÓN



REF: K-7700 COLOR: VERDE



REF: K-7703 COLOR: VERDE



REF: K-227 COLOR: VIOLETA



REF: K-227 COLOR: NEGRO

RAQUETA DE BADMINTON BÁSICA CON FORRO 1 PAR



RAQUETA PICKLEBALL ACTIVATOR

REF: 52740



BOLA PICKLEBALL X 40

3 PZAS

REF: 52821



RAQUETA PICKLEBALL PILOT

REF: 52771



RAQUETA PICKLEBALL X1000

REF: 52772



CASCO DE CICLISMO

DISEÑO AERODINÁMICO LIVIANO, PARA MAYOR COMODIDAD.

CORREAS AJUSTABLES

VISERA REMOVIBLE

CANALES DE VENTILACIÓN

MATERIAL: 20% POLICARBONATO – 80% FOAM.

REF: BHK15-1



TABLAS DE NATACIÓN

IDEALES PARA EL APRENDIZAJE Y ENTRENAMIENTO DE NIÑOS Y ADULTOS.
AYUDA A PERFECCIONAR LA TÉCNICA DE NADO Y LA FLOTABILIDAD
NO ABSORBEN AGUA, ALARGANDO LA VIDA DEL PRODUCTO Y LA HIGIENE.



REF: SB8014

TAMAÑO: 42 x 29 CMS

COLORES: VARIADOS



REF: RYP03A

TAMAÑO: 38 x 25 CMS



REF: SB8017

TAMAÑO: 39 x 31 CM

MATERIAL: ESPUMA EVA COMPRIMIDA DE ALTA CALIDAD.

COLORES: VARIADOS



REF: SB8018

TAMAÑO: 41 x 28 CM

MATERIAL: ESPUMA EVA COMPRIMIDA DE ALTA CALIDAD.

COLORES: VARIADOS



REF: SB8019

TAMAÑO: 42 x 31 CM

MATERIAL: ESPUMA EVA COMPRIMIDA DE ALTA CALIDAD.

COLORES: VARIADOS



REF: SB8016F

TAMAÑO: 41 x 28 CMS

COLOR: AZUL, ROSADO
CON AGARRE INCLUIDO



REF: RYP02

TAMAÑO: 40 CMS



GORRA PARA NATACIÓN

REF: RSIL800
COLOR: AZUL, NEGRO, SILVER
MATERIAL: SILICONE



FLOTADOR PIERNA PULL BOY

REF: RYP26 - JUNIOR
RYP26A - ADULTO



CHALECO SALVAVIDA

REF: RLV2Y200

TALLA S M L XL XXL XXXL

TUBO FLOTADOR

REF: RPN16
COLORES: VARIADOS





COMBO DE BUCEO JR

REF: SET8A



COMBO PLAYERO

REF: SET7A



FRISBEE

REF: RFB4W001

IDEAL PARA DEPORTES DE AGILIDAD Y VELOCIDAD.
FLEXIBLE Y LIGERO
ALCANCE DE 400M
DIÁMETRO: 33 CMS



BASTÓN DE RELEVO

SET DE 8 PIEZAS
REF: CT1-1



BASTÓN DE RELEVO

3.8 CM - 8 COLORES
REF: X-1405-T



DISCO DE ATLETISMO

REF: 1523 **COLOR:** Rojo **1KG**
REF: 1431 **COLOR:** Rojo **1,5KG**
REF: 1433 **COLOR:** Verde **2KG**



DISCOS

REF: T1011 - 1.0 Kg
T1011A - 1.5 Kg
T1175 - 1.75 Kg
T1012 - 2.0 Kg



BALA

REF: T10 - 10LB T14 - 14LB
T12 - 12LB 3686 - 7 2.7K



BLOQUE DE PARTIDA

REF: J-QPQ-1



JABALINA

REF: JAB600 - 600gr
JAB700 - 700gr
JAB800 - 800gr



JABALINA DE ENTRENAMIENTO

REF: 600GR-3 - 400gr - Verde



SET DE BOLAS DE BILLAR

12 PZAS

REF: BLD-1



PALO DE BILLAR

2 PZAS

REF: BLD-8



TRIÁNGULO PARA BILLAR

MATERIAL: PLÁSTICO

REF: BLD-4



TRIÁNGULO PARA BILLAR

MATERIAL: MADERA

REF: BLD-5



TIZA PARA BILLAR

12 PZAS

REF: BLD-9



TABLERO DE AJEDREZ

MEDIDAS: 50x50 CMS

REF: CH5050



TABLERO DARDOS

DIÁMETRO 17"

REF: 17115

INCLUYE DARDOS



SET 6 DARDOS

REF: BL-6008

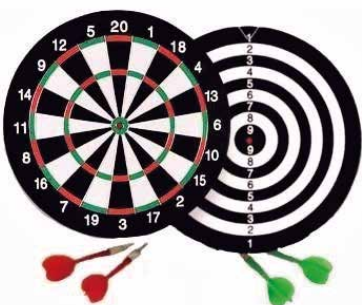

TABLERO DARDOS

DIÁMETRO 15" / 29 CM

REF: 15115

INCLUYE DARDOS



SET DE DOMINÓ

REF: 5412



JUEGO DE 3 DARDOS

3 DARDOS

REF: BL-3021A



SET DE DOMINÓ

12MM

REF: DOM12



IMPLEMENTOS PARA ENTRENAMIENTO



SET DE 5 OBSTÁCULOS PARA ENTRENAMIENTO

REF RHU9Y500

OBSTÁCULOS AJUSTABLES DE 8" A 12".

APTO PARA ENTRENAMIENTOS DE VELOCIDAD Y PRECISIÓN.



SET DE OBSTÁCULOS

REF HCRHC1812

SET DE DOS CONOS DE 18 PULGADAS DE ALTURA Y BARRA DE 1 METRO DE LARGO.



ESCALERA DE AGILIDAD

REF RAL3Y236

MEDIDAS 6 M / 20"



SET DE 6 CONOS HELIX

REF RC93Y836



SET DE 10 CONOS 2" PRO

REF RC23Y102



CONO PLANO 2" TIPO PLATO

REF PRO2 - OR
POR UNIDAD



SET DE 10 CONOS PLÁSTICOS 2"

REF RCS9Y102



SET DE 50 CONOS PLANOS 2" TIPO PLATO

50 UNID 10 x COLOR
INCLUYE GANCHO PARA GUARDAR
Y TRANSPORTAR
REF R6050



CONOS PLÁSTICOS

REF PRO 7 - 7" / 17.8 cm
PRO 9 - 9" / 22.8 cm
PRO12 - 12" / 30.5 cm
PRO15 - 15" / 38 cm
PRO18 - 18" / 45.7 cm



SET DE 4 AROS DE AGILIDAD

REF RAR3Y840
MEDIDAS 40 CM

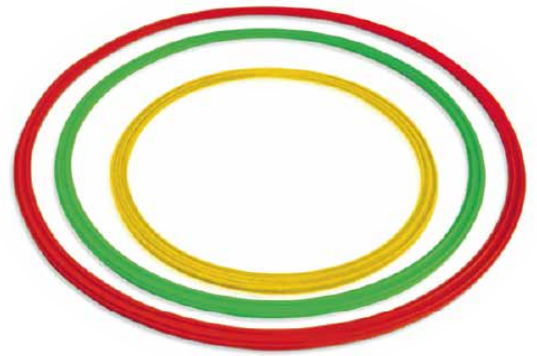

HULA HOOP PLANO

REF	FR400	40 CM	AMARILLO
	FR500	50 CM	VERDE
	FR600	60 CM	ROJO
	POR UNIDAD		

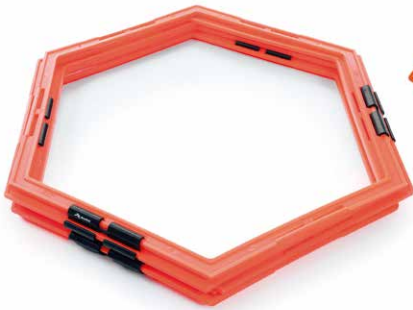

SET DE 6 AROS DE AGILIDAD

REF RAR3Y050
MEDIDAS 50 CM

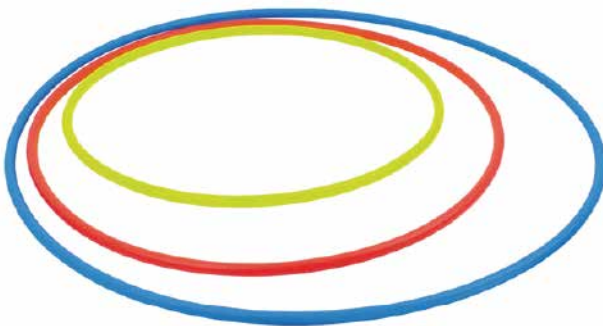

HULA HOOP CILÍNDRICO

REF	HH450	45 CM	AMARILLO
	HH550	55 CM	ROJO
	HH650	65 CM	AZUL
	HH750	75 CM	VERDE
	HH850	85 CM	ROJO
	POR UNIDAD		



POSTE DE AGILIDAD CON BASE

REF RM12291
MEDIDAS 160 X 2.5 CM
INDIVIDUAL



PISO DE CAUCHO PARA GIMNASIOS

VERSÁTIL EN EL HOGAR, GIMNASIO, SALA DE JUEGOS, ENTRE OTROS

PROPORCIONA UN COJÍN A LAS SUPERFICIES DE PISOS DUROS EN SALAS DE JUEGOS, AULAS, GIMNASIOS Y MÁS.

PERFECTOS PARA EJERCICIO, GIMNASIA, YOGA, CROSSFIT, PILATES, MMA, ÁREAS DE JUEGO PARA NIÑOS, GUARDERÍAS, TALLERES, SALAS DE FITNESS.

LAS PIEZAS GRANDES, ACOLCHADAS SON SEGURAS; NO SOLO PARA LOS EJERCICIO, SINO TAMBIÉN PARA PROTEGER CONTRA DAÑOS EL SUELO.

SUPERFICIE DE ALFOMBRA ANTIDESLIZANTE CON PROPIEDADES DE AMORTIGUACIÓN EXCEPCIONALES.

AMORTIGUADOR DE IMPACTO Y SONIDO.

HECHO DE CAUCHO LO QUE OFRECE UNA MAYOR DURABILIDAD.

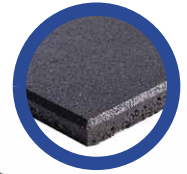

PISO DE CAUCHO

MEDIDA: 50 x 50 x 1.5 CM

REF: RTH05015

INDIVIDUAL



PISO DE CAUCHO INTERCONECTABLE

REF: RF2W50501

MATERIAL: CAUCHO

MEDIDA: 50 x 50 x 1 CM

4 PIEZAS

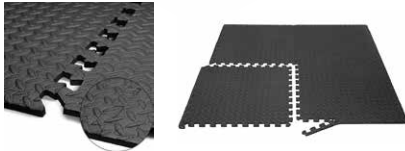
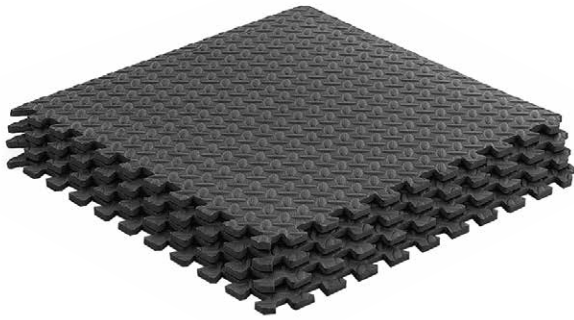

SET DE 4 INTERLOCKING MAT

REF: RPMOT612
MATERIAL: EVA FOAM
MEDIDA: 61 x 61 x 1.2 CM
4 PIEZAS



COLCHONETA PARA EJERCICIO

REF: 1
MATERIAL: PVC ACOLCHADO.
ANTIBACTERIAL
MEDIDA: 173 x 61 cm

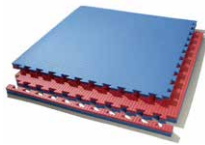
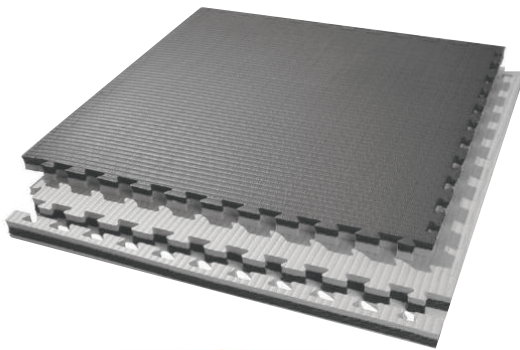

COLCHONETA PARA ARTE MARCIAL TATAMI

REF: RMTKD1001 - BK/GY
RMTKD1001 - BL/RD
MATERIAL: FOAM
MEDIDA: 100 x 100 x 2 CM
INDIVIDUAL



COLCHONETA PLEGABLE DLX

REF: EM-12D
MATERIAL: PVC, ACOLCHADA
ALTA RESISTENCIA
MEDIDA: 180 x 60 x 4 cm



TRAMPOLÍN 40"

MEDIDAS: 100 CM DIA. x 20 ALT. CM
 6 PATAS DE 18 CM x 2.5CM CON GOMA
 ANTIDESLIZANTE
 MARCO CIRCULAR 1" x 1" HIERRO ESMALTADO
 MALLA POLIPROPILENO NEGRO RESISTENTE
 RAYOS UV
 RESORTES DIÁMETRO EXTERIOR 1,8 CM
 / ACERO GALVANIZADO
CAPACIDAD MÁXIMA: 90 KILOS
REF: HL-2064

A.



B.



STEP PARA AERÓBICOS

A. MEDIDAS: 110 x 36 x 20 CM
REF: STP-T015
B. MEDIDAS: 70 x 30 x 15 CM
REF: 1210S



PROTECTOR BUCAL SENCILLO

INCLUYE ESTUCHE

REF: MGGA001
MGGA001 - JR



HAND GRIP AJUSTABLE

RESISTENCIA: 10 A 40 KG

REF: RHGOW90



PROTECTOR BUCAL DOBLE

INCLUYE ESTUCHE

REF: MGGA002
MGGA002 - JR



HAND GRIP

MANGO FOAM

COLORES: BL / NYW / PK

REF: HG02B2



PROTECTOR BUCAL

INCLUYE ESTUCHE

REF: 5917-0001 - NEGRO
5917-0301 - VERDE NEON



GUANTE DE PESAS HAMMER

REF: RWG3H100

TALLA S M L XL



GUANTE PARA PESAS

REF: WGKR769

TALLA S M L XL



GUANTE PARA PESAS CON MUÑEQUERA

REF: WGKR772

TALLA S M L XL



FAJA DE NEOPRENO

REF: RWB610 10"
RWB612 12"

COLORES: NEGRO, NAVY

SE AJUSTA DE FORMA NATURAL AL CUERPO CIERRE DE VELCRO GENERA Y RETIENE EL CALOR DURANTE EL ENTRENAMIENTO AYUDA A LA POSTURA Y ESPALDA BAJA



GUANTE PARA PESAS

REF: WGKR775

TALLA S M L XL



SUSPENSORIO CON COPA

REF: RSC5K72

TALLA YM YL - S M L XL



PORTA BOTELLAS

REF: J2CB875
CAPACIDAD: 8 UNIDADES
COLOR: AZUL
MATERIAL: PLÁSTICO



MUÑEQUERA SURTIDA

REF: RWB4
COLORES: NEGRO, NAVY, ROJO



MALETÍN DUFFLE

REF: RDB9B002 NAVY / RED
TAMANO: 60 x 30 x 28 cm



PORTA TACOS

REF: RSB061 NAVY / RED.
RSB062 BLACK / ORANGE

TAMANO: 36 x 17 x 18 cm





BOLSO DE BALONES

REF: RBB600

CAPACIDAD: APROX. 20 BALONES #5



RED PARA BOLAS

REF: T4029N

CAPACIDAD: APROX. 20 BOLAS #5





CARRITO PARA TRANSPORTAR BALONES EN CANCHA

REF: RKT3Y886

ALTURA TOTAL: 90 CMS

TAMAÑO CESTA: 65 X 65 X 45 CMS



CARRO DISPENSADOR DE BALONES

REF: RBC8M200

TAMAÑO: 127 x 56 x 29 cm

CARRITO DEPORTIVO PORTÁTIL PLEGABLE. FABRICADO EN ACERO CROMADO DE ALTA RESISTENCIA.

FUNDA FABRICADA EN NYLON REFORZADO. ADECUADO PARA TODO TIPO DE BALONES. PORTÁTIL CON RUEDAS.





TABLÉRO DE ANOTACIÓN SCORE

REF: 70036B

DIMENSIONES: 53 X 25 cm

FÁCIL DE USAR; PLEGABLE Y TRANSPORTABLE.



TABLÉRO DE ANOTACIÓN SCORE

REF: 70036A



BOMBA DE INFLAR

REF: RPB3Y162



BOMBA DE INFLAR CON MEDIDOR

REF: YB062
ACERO INOXIDABLE
PARA TODO TIPO DE VÁLVULA



INFLADOR

REF: RM-40E
DOBLE ACCIÓN
(INFLA Y DESINFLA)
INLCUYE AGUJA



BOMBA DE INFLAR

REF: YB061
PLÁSTICA PARA TODO TIPO
DE VÁLVULA



AGUJA

REF: AGUJA



MEDIDOR DE PRESIÓN

REF: ZH632
INLCUYE 2 AGUJAS DE REPUESTO



CRONÓMETRO SENCILLO

REF JS307

DIGITAL CON CORDÓN, RÁPIDO REINICIO
CALENDARIO Y RELOJ, ALARMA DIARIA
PEDÓMETRO, INCLUYE BATERÍA



CRONÓMETRO 10 MEMORIAS

REF JS506

RÁPIDO REINICIO CALENDARIO Y RELOJ
ALARMA DIARIA, PEDÓMETRO
RESISTENTE AL AGUA
INCLUYE BATERÍA



SILBATO CON CORDÓN

REF RWH9Y001



PITO PLÁSTICO CON CORDÓN

REF PW6L
INDIVIDUAL



SILBATO PLÁSTICO 12 UNID

REF CY318

MEDIDOR DE PRESIÓN DIGITAL FOX 40®

REF: 6906-0200

ASEGURA LA PRESIÓN DE AIRE EXACTA, PARA CUALQUIER BOLA INFLABLE. DISEÑADO CON UNA VÁLVULA DE AIRE DE LIBERACIÓN RÁPIDA, QUE PERMITE QUE EL AIRE SE DESCARGUE SIN QUITAR EL PASADOR O EL CALIBRE DE LA BOLA, LO QUE GARANTIZA QUE LAS BOLAS INFLADAS DE FORMA EXCESIVA OBTENGAN UNA PRESIÓN DE AIRE INMEDIATA Y ABSOLUTAMENTE PRECISA. OPCIONES DE PSI, BAR, KG Y KPA DISPONIBLES. EL MODO PREDETERMINADO ES PSI. LOS PASADORES ESTÁN HECHOS DE ALEACIÓN DE ZINC. **INCLUYE:** 2 AGUJAS DE REPUESTO.



KIT SPORT FOX 40®

REF: 6906-0000

INCLUYE: SILBATO PEALISS FOX 40® CLASSIC® (115 DB), INFLADOR Y 3 AGUJAS.





PITO SONIK CMG®

REF 9200-0008

POTENCIA DE SONIDO 120 DB

DISEÑO 2 CÁMARAS + CMG

EL FOX 40 SONIK BLAST® CMG® ES EL MÁS EFICIENTE SILBATO EN SU CLASE. BOQUILLA AMORTIGUADA EN MATERIAL TERMOPLASTICO QUE PROPORCIONA AGARRE SUPERIOR Y PROTECCIÓN DE LOS DIENTES. DISTINGUIDO, FUERTE Y SONIDO CLARO AL OÍDO HASTA 1 MILLA DE DISTANCIA. EL MODELO FINGERGRIP SE AJUSTA DE FORMA SEGURA Y CÓMODA SOBRE EL GRUPO DE DEDOS



PITO MINI CMG®

REF 9400-0008

POTENCIA DE SONIDO 109 DB

DISEÑO 3 CÁMARAS + CMG

EL FOX 40 MINI CMG ES UNA VERSIÓN MÁS COMPACTA DEL FOX 40 CLASSIC CMG CON UNA BOQUILLA MÁS PEQUEÑA EL MATERIAL TERMOPLÁSTICO AMORTIGUADO DE LA BOCA (CMG) PROPORCIONA UN AGARRE Y UNA PROTECCIÓN SUPERIOR PARA LOS DIENTES. PRODUCE UN TONO AGUDO Y ULTRA-ESTRIDENTE





PITO FOX 40® SAFETY

REF 9702-0008 BK 9702-0108 RD
9702-0508 BL 9702-1308 YW
9702-1408 GN

POTENCIA DE SONIDO 90 DB

DISEÑO 2 CÁMARAS

LA FOX 40® PEARL™ TIENE UN TONO DIFERENTE, ES IDEAL PARA JUEGOS MULTI-CAMPO. PERFECTO PARA LOS QUE NECESITAN SILBATO SONANTE Y PENETRANTE, QUE OPAQUE EL RUIDO AMBIENTAL

PITO FOX 40® CLASSIC

REF 9902-0000 BK 9902-0100 RD
9902-0500 BL 9902-1300 YW
9902-1400 GN

POTENCIA DE SONIDO 115 DB

DISEÑO 3 CÁMARAS

EL FOX 40® CLASSIC™ IDEAL PARA LOS ARBITROS Y ENTRENADORES DE TODO NIVEL, ES UN SILBATO IMPECABLE, CONSISTENTE Y FIABLE. ALCANDE DE 1 MILLA DE DISTANCIA. EL MODELO FINGERGRIP SE AJUSTA DE FORMA SEGURA Y CÓMODA SOBRE EL GRUPO DE DEDOS



PITO FOX 40® XPL LIGHT Y MICRO NEON

REF 7918-1400 GN



PITO CLASSIC CMG

REF 9602-0000



PITO CLASSIC CMG

REF 9600-0008

POTENCIA DE SONIDO 115 DB

DISEÑO 3 CÁMARAS SIN GAS + CMG

IDEAL PARA AQUELLOS CON LA NECESIDAD DE SOSTENER EL SILBATO EN LA BOCA POR AMPLIOS PERÍODOS DE TIEMPO. EL MATERIAL TERMOPLÁSTICO AMORTIGUADO DE LA BOCA (CMG) PROPORCIONA UN AGARRE Y UNA PROTECCIÓN SUPERIOR PARA LOS DIENTES .



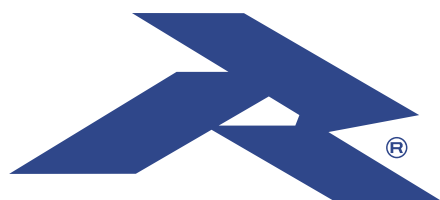

PARA MAYOR INFORMACIÓN CONTACTE A SU EJECUTIVO DE VENTAS

DEPORTES JIMMY CR S.A
Ofibodegas Capri, Bodega #20, de Multiplaza Escazú, 1 km al norte,
contiguo al Colegio Blue Valley. Guachipelín.
San José. Costa Rica

C: ventascr@djimmy.net

W: (506) 7012 4297

T: (506) 2215 1578
(506) 2215 1745



@runic.cr